

EPDM THREADED EXPANSION JOINT PN16



Size : DN 1/2" to 3"
Ends : Threaded BSP
Min Temperature : - 10°C
Max Temperature : + 100°C
Max Pressure : 16 Bars
Specifications : Absorb vibrations and noises
Linear and angular compansion
Double sphere

Materials : Cast iron fittings

EPDM THREADED EXPANSION JOINT PN16

SPECIFICATIONS :

- Absorb vibration, noises and expansion
- Linear and angular compansion
- Double sphere EPDM (EPDM marking)
- Cast iron fittings threaded BSP

Marking example :



USE :

- Water distribution
- Min Temperature : - 10°C
- Max Temperature Ts : + 100°C
- Max Pressure Ps : 16 bars (see graph)

PRESSURE / TEMPERATURE GRAPH (STEAM EXCLUDED) :

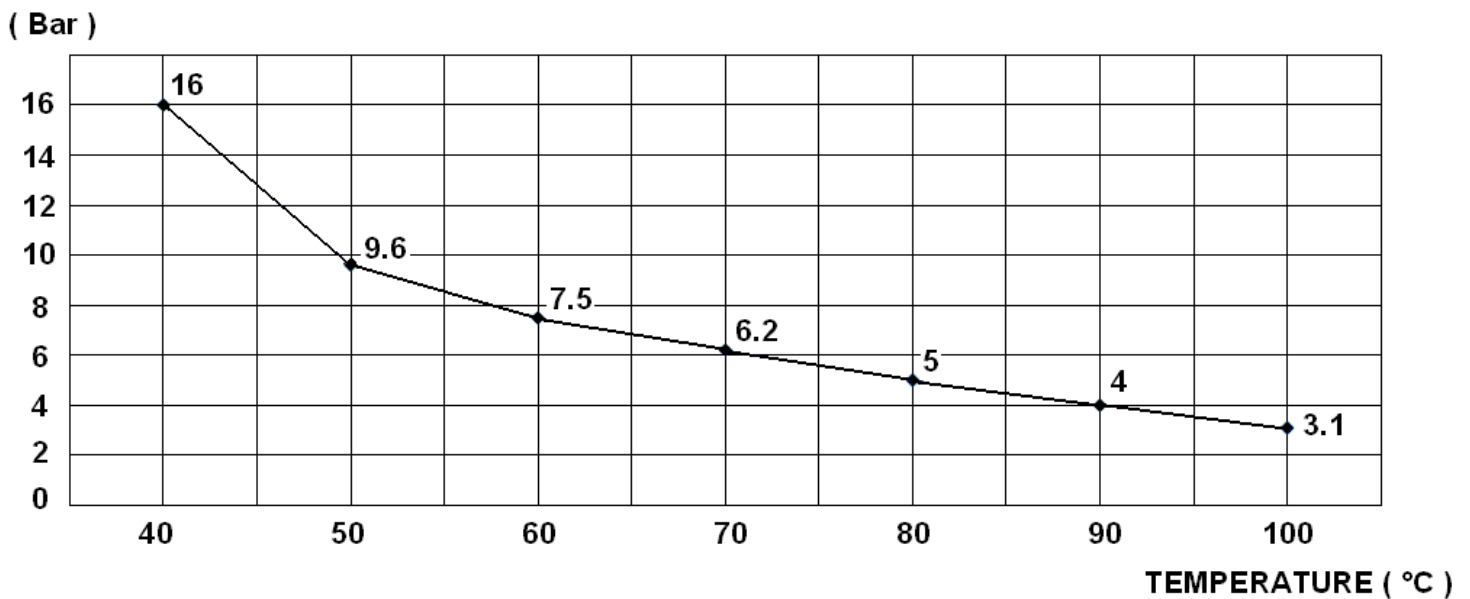

RANGE :

- EPDM expansion joint with cast iron fittings threaded BSP from DN 1/2" to DN 3" Ref. 1504

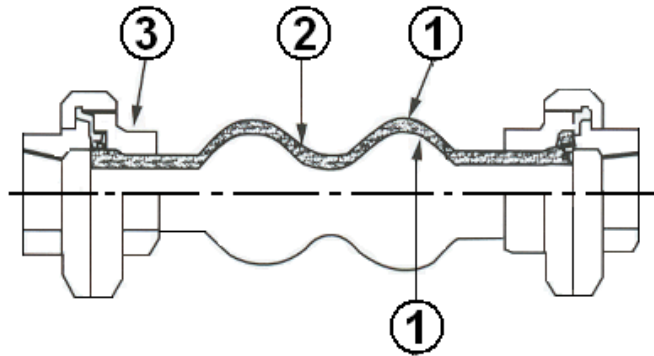
EPDM THREADED EXPANSION JOINT PN16
MATERIALS :

Item	Designation	Materials
1	Inner tube and cover	EPDM
2	Reinforcement	Nylon cord
3	Fittings	Galvanized cast iron

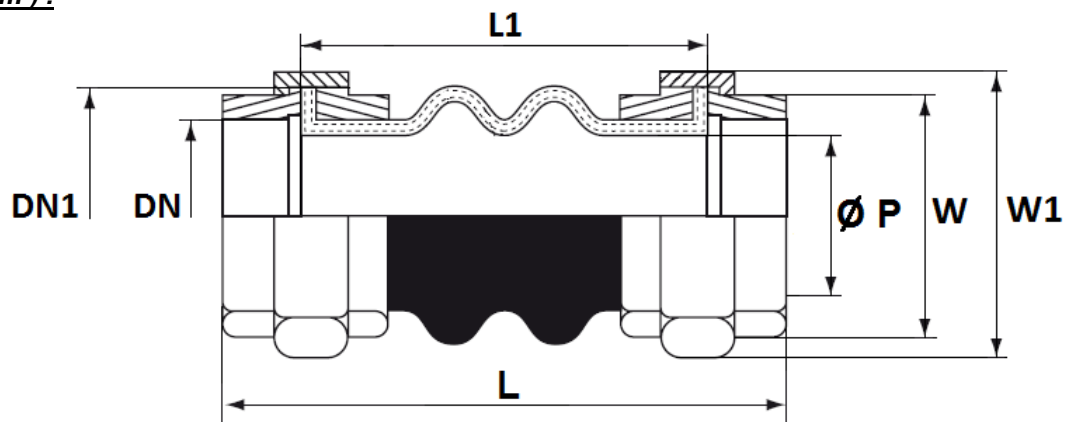
SIZE (in mm) :

Ref.	DN	1/2"	3/4"	1"	1"1/4	1"1/2	2"	2"1/2	3"
1504	DN1	M42	M42	M52	M60	M68	M82	M98	M115
	L	200	200	200	200	200	200	240	240
	L1	151	151	150	143	137	130	166	156
	Ø P	14	16	21	25	32	42	58	62
	W (on flat)	27	33	41	50	55	69	85	97
	W1 (on flat)	49	49	60	70	79	95	113	127
	Weight (Kg)	0.43	0.63	0.94	1.41	1.77	2.32	3.58	4.88

 Sferaco 90 rue du Ruisseau 38297 St Quentin Fallavier Tel: + 33 (0) 474.94.15.90 Fax: + 33 (0) 474.95.62.08 Internet: www.sferaco.fr E-mail: sferaco@sferaco.fr

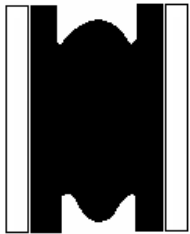
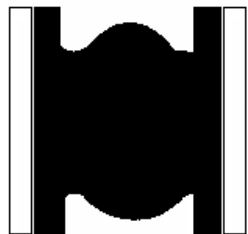
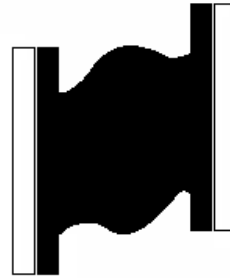
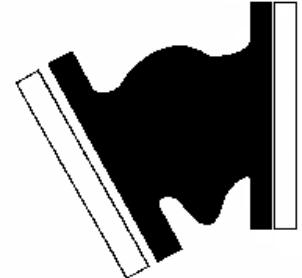
EPDM THREADED EXPANSION JOINT PN16
MOVEMENTS (in mm) :

Compansion

Expansion

Lateral

Angular

DN	1/2"	3/4"	1"	1"1/4	1"1/2	2"	2"1/2	3"
Compansion	22	22	22	22	22	22	22	22
Expansion	6	6	6	6	6	6	6	6
Lateral	22	22	22	22	22	22	22	22
Angular	30°	30°	30°	30°	30°	20°	15°	15°

STANDARDS :

- Fabrication according to ISO 9001 : 2015
- DIRECTIVE 2014/68/EU : Products excluded from directive (Article 4, § 3)
- Threaded BSP conical fittings according to ISO 7/1 Rc

ADVICE : Our opinion and our advice are not guaranteed and SFERACO shall not be liable for the consequences of damages. The customer must check the right choice of the products with the real service conditions.

EPDM THREADED EXPANSION JOINT PN16

INSTALLATION INSTRUCTION :

Expansion joint are designed for the absorption of previously specified movements under specific pressure and temperature conditions. So that the maximum service life is achieved, the following items must be observed during installation.

- Prior to fitment of the compensator it must be ensured that :
 - The route of the pipeline is straight - The expansion tallies with that of the chosen compensator
 - The expansion tallies with that of The chosen compensator
 - The fixes points are dimensionned so that they can absorb the reaction forces and stiffness rate that arise during use.
 - The pipeline is limited by fixed points
 - The distance between compensator and bearing may be a maximum of 3 times the pipe diameter. Place only one compensator between 2 bearings.
- Each pipe elbow must be fixed by support, specially if compensator is mounted with limiters. Fixed bearings are necessary because compensator is submitted to expansion when it is under pressure.
- Expansion joint must not be painted and heat-insulated. It must be protected from bad weather and solar radiation.
- Please apply the following stages order :
 - a) Fixed points for above pipeline
 - b) Fixed points for down pipeline
 - c) Compensator mounting
- Installation layout :

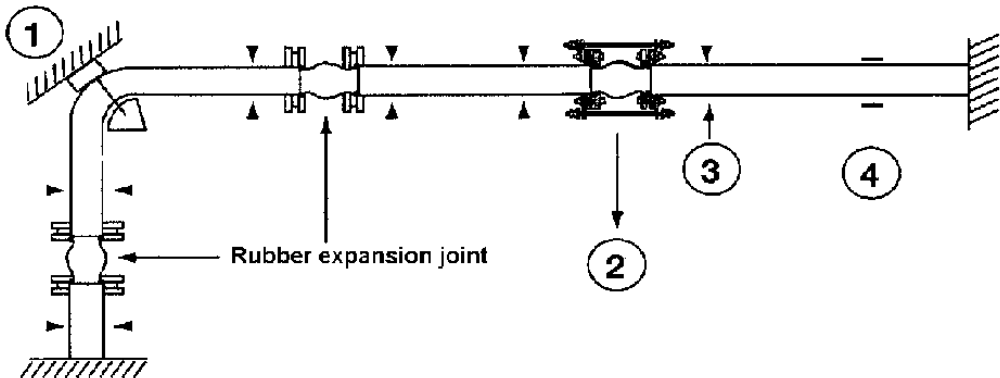

1. Fixed points
2. With limiters
3. Bearings
4. Pipe guides

- Check that the compensator is not subjected to the weight of the pipeline. The installation lenght must agree with the installation gap. The compensator must never be twisted. It is recommended that specific characteristics be observed during maintenance :
 - The compensator must never be painted or recovered by heat insulation
 - The tightness of the bolts must be checked often.
 - The flanges must be perfectly cleared

NOTA : The life of compensator can vary because of working conditions (fluids, pressure, temperature), that is why it is necessary to check it regullary.

WRONG INSTALLATION :

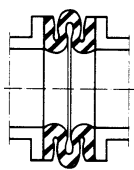

Excessive
compansion

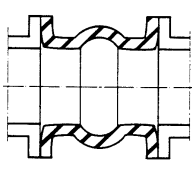

Excessive
expansion

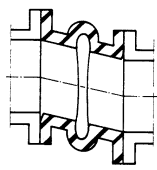

Cutting too
important

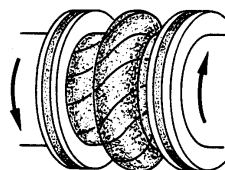

Torsion

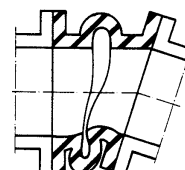

Important compansion
and angular deviation

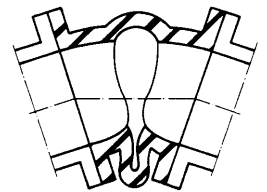

Angular deviation
too important